

Midi Torch

Zones: 0, 1, 2, 20, 21 and 22



Product Overview

The Midi Torch is a compact high power LED pocket torch delivering excellent illumination, robustness and reliability in the most extreme conditions and is CE marked to the ATEX Directive and IECEx certified for safe use in Zones 0,1 and 2 potentially explosive gas and Zones 20, 21 and 22 dust atmospheres.

With a smooth, easy grip, ergonomic enclosure and a high output LED light source, giving up to 210 lumens of light output and bespoke optics delivering a narrow high intensity beam and, at the same time, a lower output wide angle fringe light, the Midi Torch is ideal for inspection and maintenance work in conditions of darkness or reduced visibility.

The single-handed push button switch with rubberised switch cover and raised surface enable easy switching, even with gloved hands, and shrouded to avoid inadvertent operation. The strong, durable torch body enclosure has excellent chemical resistant properties and a proven impact resistance, even at sub zero temperatures. The rubber armoured lens ring gives enhanced grip and shock protection with a shatterproof polycarbonate lens providing excellent resistance to impact damage. It is sealed dust tight and protected from water immersion with an IP67 rated enclosure. The straight body configuration has an anti-roll foot allowing it to be placed securely on its base or side.

The Midi Torch has a battery duration of up to 7 hours, after which it is recommended that the user replaces the batteries to avoid the risk of battery leakage, the high power LED light source is 'fitted for life'. The torch's internal construction is a one-piece assembly with LED, circuit, switch and battery cassette for easy replacement of the 4 AA alkaline primary cells. Details of the specific approved AA cells for use in T4 gas atmospheres can be found in the instruction manual; all other AA alkaline primary cell types allow for use in maximum T3 rated Zone 0 areas.

Features & Benefits

- ATEX and IECEx certified for Zones 0 and 20 explosive gas and dust atmospheres
- 210 lumen high output LED light source
- IIC Gas Group / T3/T4 temperature class
- IIIB Dust Group / 200° C maximum surface temperature
- Midi compact size
- Compact & robust ergonomic design
- Single handed switch with switch protection shroud
- IP67 water and dust tight
- Group I M1 Mining approval
- Supplied with T4 approved cells and a wrist strap (do not attach and use wrist strap in Zone 0/20 areas or applications)

Certifications



1180

IMPA Code

79 22 80

Technical Specification

Product Reference		M-85
Product Description		ATEX Midi Safety Torch with LED Primary Cell Powered
Code	Industrial	II 1G Ex ia IIC T3/T4 Ga IP67 II 1D Ex ia IIIB T200°C Da
	Mining	I M1 Ex ia I Ma IP67
Type of Protection		'ia' Intrinsic Safety
Area of Classification (Gas)		Zone 0, Gas Group IIC
Temp. Classification (Gas)		T3/T4
Area of Classification (Dust)		Zone 20 Dust Groups IIIA and IIIB
Max Surface Temperature (Dust)		200°C
Ambient temperature		-40°C to +40°C
Certificate		Baseefa11ATEX0236X / IECEx BAS 11.0116X
Enclosure		Impact Resistant Thermoplastic, Electrostatic Non-hazardous
Lens		Polycarbonate, Impact Resistant
Beam Type		Narrow Spot with Wide Angle Fringe Light
Light Source:	Type	High Power LED
	Output	Up to 210 lm
	Life	25,000+ hours (fitted for life)
Power Source:	Part Number	TP-295 (4 x LR6 Cells)
	Battery Type	LR6 Primary Cells, to IEC 60086, Alkaline AA
	Volts	4 x 1.5v
Light Duration		Up to 7 hours
Ingress Protection		IP67
Weight (incl. battery)		0.190Kg

- All information has been gathered under laboratory conditions, the user must regard the values given as approximate.
- Changes may be made to the above specification without notification, details are available on request.

Product Dimensions

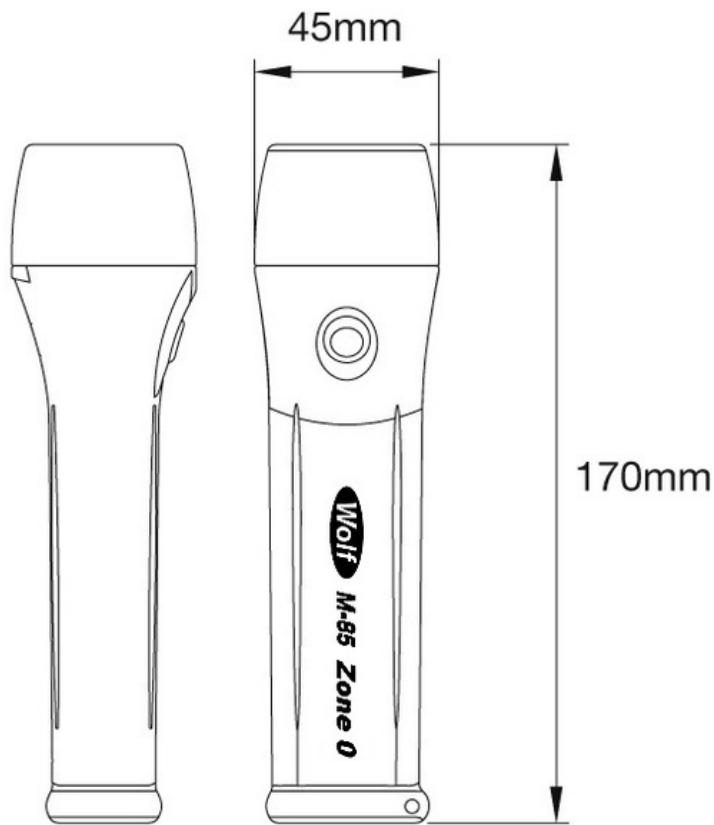

Light Output

210 lumens LED Spot Beam (approx 7°) with a Wide Angle Fringe Beam (approx 55°)

Peak luminous intensity at 1m **6500 lux**, at 2.5m **1233 lux**

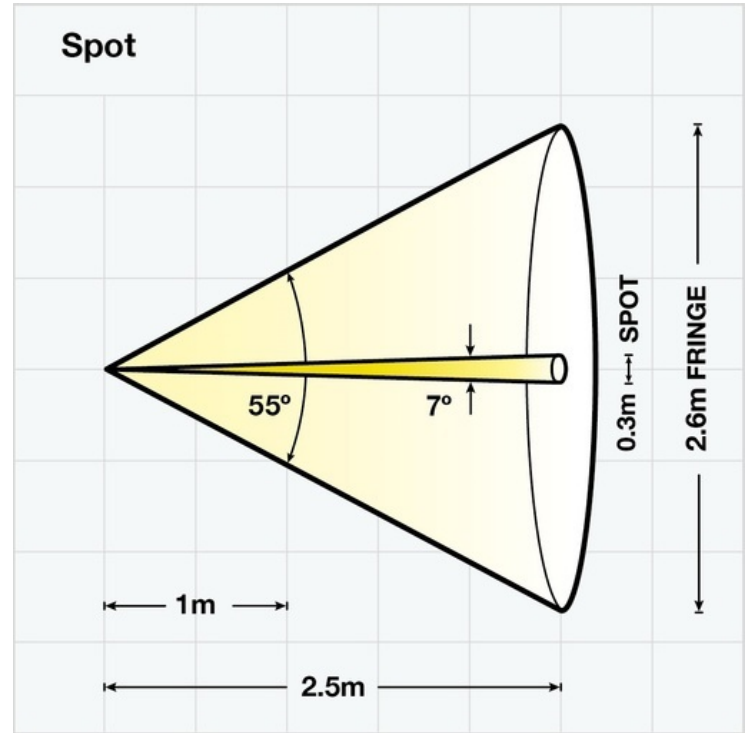

Version: SL036 DF444 Issue 5

Wolf[®]

Wolf Safety Lamp Company, Saxon Road Works, Sheffield, S8 0YA, UK

T: +44 (0) 114 255 1051

F: +44 (0) 114 255 7988

E: info@wolf-safety.co.uk

www.wolf-safety.co.uk

